















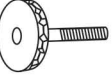

1# 2PCS	2# 2PCS	3# 1PCS	4# 1PCS	5# 2PCS
				
6# 1PCS	7# 1PCS	8# 1PCS	9# 2PCS	10# 4PCS
				
11# 2PCS	12# 2PCS	13# 2PCS	14# 2PCS	15# 1PCS
				
16# 2PCS	A: 4PCS	B: 4PCS	C: 2PCS	D: 1PCS
				
E: 8PCS	1PCS	1PCS		

2

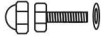

3

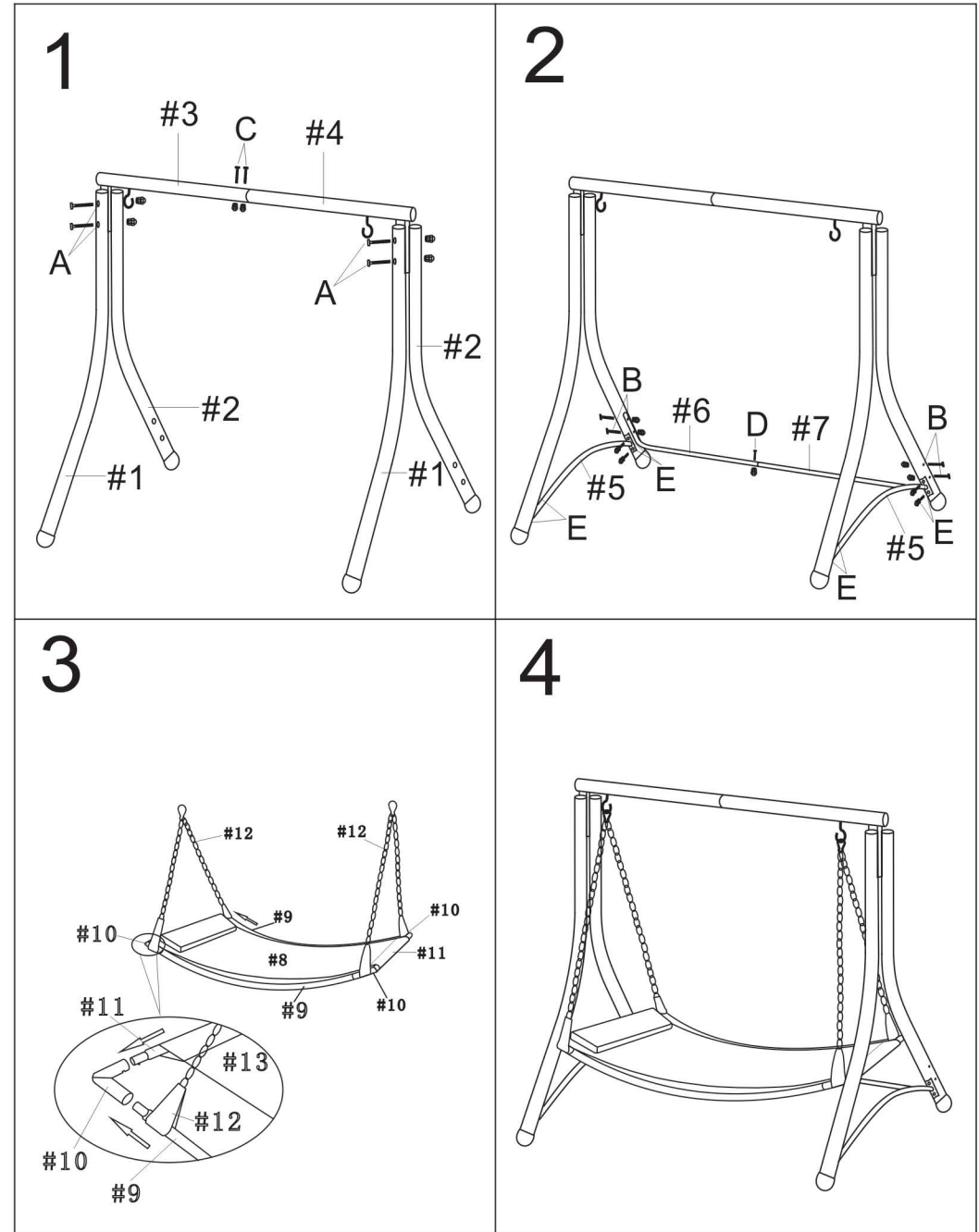
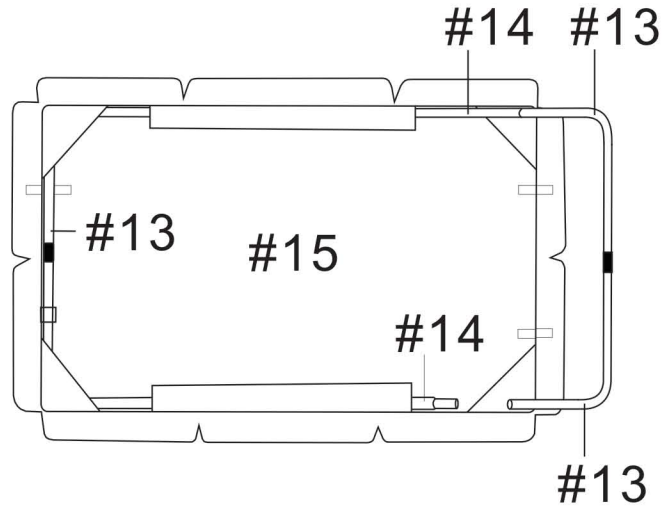
5



6

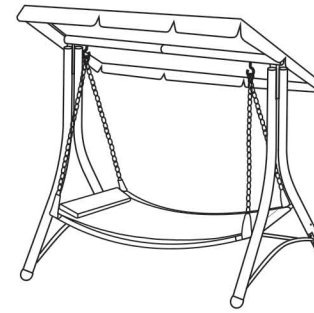
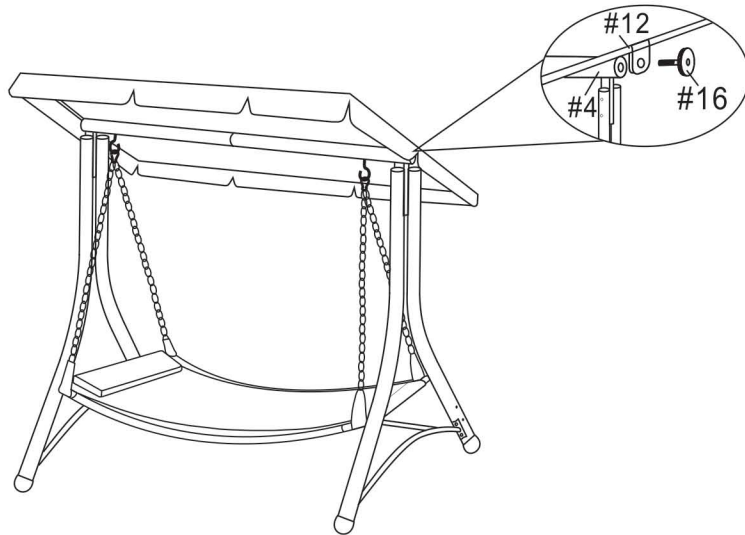

ATTENTION

Les sacs de plastique peuvent être dangereux .
Pour éviter le danger de suffocation, ne laissez pas ce sac à la portée des bébés et des enfants!

VORSICHT

Plastiktaschen können gefährlich sein.
Um die Gefahr des Erstickens auszuschliessen ,bitte diesen Beutel nie in Reichweite von Säuglingen und Kleinkindern ablegen!

CAUTION

Plastic bags can be dangerous. To avoid danger of suffocation, keep this bag away from babies and children !

ATTENZIONE

Il sacchetto di plastica possono essere pericoloso.
Per evitare il pericolo di suffocation, tieni questo sacchetto lontano da bambini e fanciulli.

PRECAUCIÓN

Las bolsas de plástico pueden ser peligrosas.
¡Para evitar el peligro de asfixia, Mantenga la bolsas fuera del alcance de niños y bebés.

ADVARSEL

Plastposer er Farlige for Børn toenk på kvoelningsfaren.



THIS PRODUCT HAS BEEN MANUFACTURED ON TREATED METAL.
IF THIS METAL WOULD DAMAGE BY, FOR EXAMPLE, A SHOCK,
WE RECOMMEND TO USE A PRODUCT TO AVOID OXIDE. WE RECOMMEND
ALSO TO KEEP THIS ARTICLE INSIDE OR TO USE A COVER TO
PROTECT FROM RAIN WHAT WOULD EXTEND PRODUCT LIFE.